

CROC  
toys

# NOTICE DE MONTAGE BUILDING INSTRUCTION



1



Séparer délicatement les pièces des  
planches.

Gently detach all the pieces from the  
boards.



2

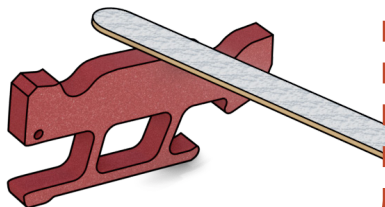

Poncer les attaches restantes à l'aide  
de la cale.

Sand the leftover attachment tabs with  
the included file.

3

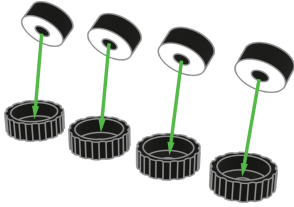

Collez les roues sérigraphées dans les surroues.

⚠ Retirer l'excédent de colle si nécessaire avec une tige.

Glue the printed wheels inside the wheel extensions

⚠ Remove any excess glue with a dowel if necessary

4

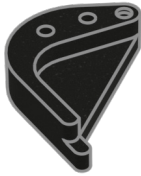

Localiser la première pièce du godet.

Find this first bucket piece.

5

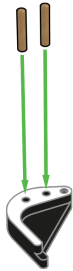

Encoller la pièce et placez deux **petites** tiges.

Place glue on the face of the piece and then insert two **small** dowels.

6

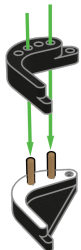

Placer la pièce suivante du godet.

Glue and place the second piece.

7

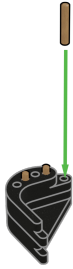

Insérer une **petite** tige dans le trou le plus bas **SANS LA COLLER.**

Insert a **small** dowel in the bottom hole **WITHOUT GLUING.**

8



Insérer le bras de la pelle sur la tige **SANS LA COLLER.**

Insert the excavator arm on the dowel **WITHOUT GLUING.**

9

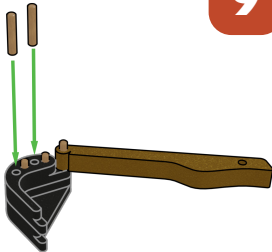

Insérer deux **petites** tiges dans les trous restants.

Insert two **small** dowels in the remaining holes.

10

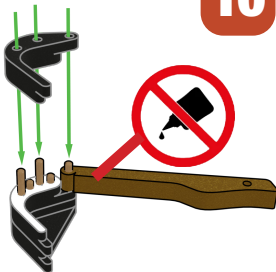

Coller la pièce suivante du godet **SANS COLLER LE BRAS DE LA PELLE.**

Glue on the next bucket piece **WITHOUT GLUING THE ARM.**

11

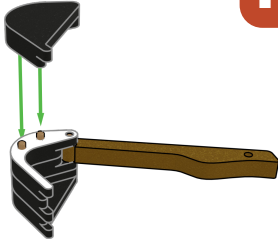

Coller la dernière pièce du godet.

Glue on the last bucket piece.

12

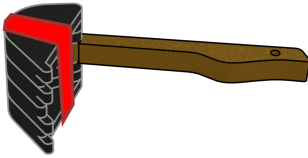

Utiliser des élastiques pour maintenir le godet le temps que la colle prenne (20 minutes)

**Astuce :** Bouger le bras régulièrement pendant le séchage pour éviter qu'il ne se colle au godet.

Use the elastic bands to clamp the bucket while the glue dry.

**Tip :** Move the arm regularly so it does not stick to the bucket.

13

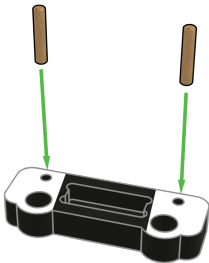

Encoller la première pièce de la base (en évitant la partie centrale) et insérer deux **petites** tiges.

Place glue on the first base piece (avoiding its middle part) and then insert two **small** dowels.

14

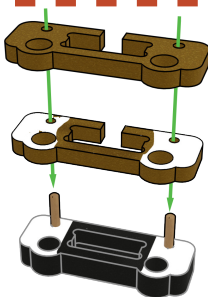

Encoller et insérer les deux pièces centrale de la même façon.

Glue and inset in place the two central sections (still avoiding the middle area).

15



Insérer la table tournante **SANS LA COLLER.**

Insert the turntable wheel **WITHOUT GLUING IT.**

16

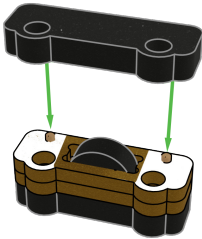

Coller la dernière pièce de la base toujours en évitant la partie centrale.

Glue on the last piece of the base, still avoiding the middle areal with the glue.

17

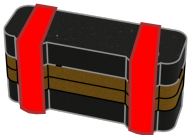

Utiliser les élastiques pour maintenir la pression pendant que la colle sèche.

Retirer l'excédent de colle si nécessaire

Use the elastic bands to clamp the excavator base while the glue dry.

If necessary, remove any excess glue.

18

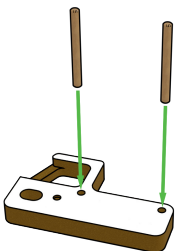

Encoller la première pièce de la tourelle et insérer deux **grandes** tiges

Place glue on the first piece of the turret.

19

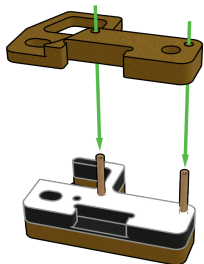

Coller les deux pièces suivantes.

Glue and insert in place the two next pieces.

20

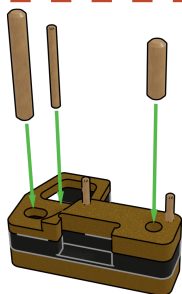

Placer les tiges comme indiqué **SANS LES COLLER.**

Place the dowels as shown **WITHOUT GLUING THEM.**

21

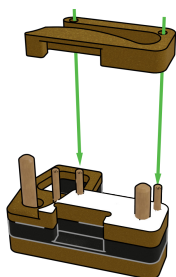

Coller la pièce suivante.

Glue on the next piece.

22

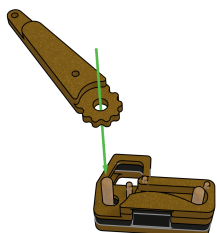

Placer la première moitié du bras de la pelle **SANS COLLER.**

Place the first part of the boom **WITHOUT GLUING IT.**

23

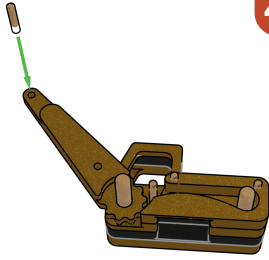

Coller une **petit** tige au bout du bras de la pelle.

Glue a **small** dowel on the end of the boom.

24

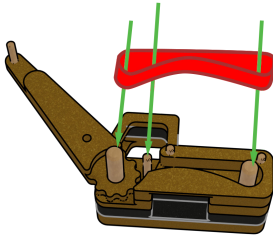

Enfiler un élastique autour des deux axes en incluant la tige du milieu. (voir image ci-contre et suivante).

Insert the elastic band around the three dowels as shown.

25

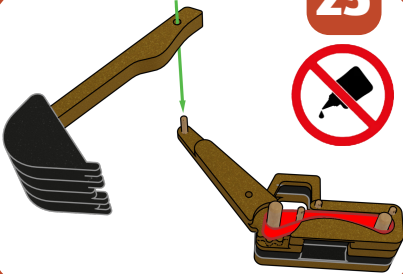

Enfiler la pièce du bras incluant le godet **SANS LA COLLER**.

Insert in place the arm and bucket assembly **WITHOUT GLUING IT**.

26

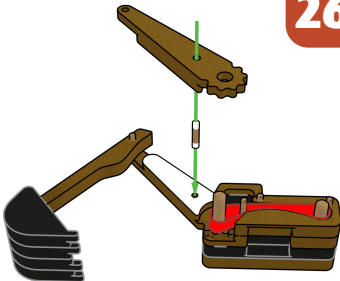

Coller la troisième partie du bras de la grue en incluant une **petite** tige.

Glue on the second part of the boom including a **small** dowel.

27

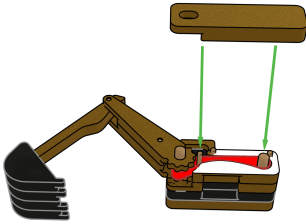

Coller la dernière pièce latérale du corps de la pelle.

Glue on the last piece of the turret.

28

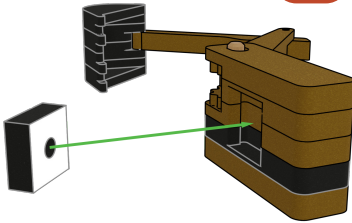

Coller la table tournante.

Glue the turntable.

29

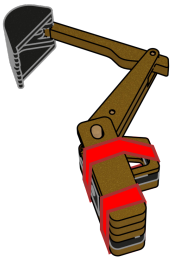

Utiliser des élastiques pour maintenir la pression pendant que la colle sèche.

**Astuce** : Bouger le bras et le godet régulièrement pendant le séchage pour éviter qu'ils ne se collent au châssis.

Use the elastic bands to clamp while the glue dry.

**Tip** : Move the arm regularly so it does not stick.

30

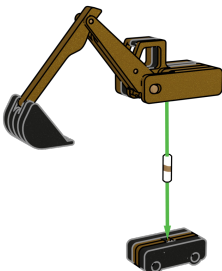

Coller un axe dans les deux tables tournantes.

**Attention**

Ne mettre de la colle que sur les bouts de l'axe.

Glue the axle onto the two turn tables.

**Be careful**

Only glue the axle tips.



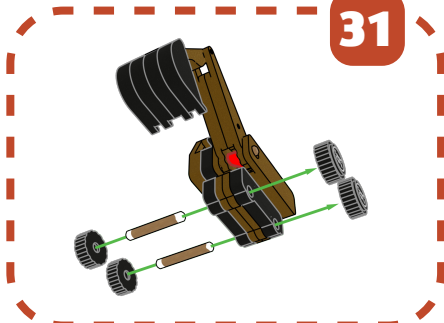

31

Coller les roues restantes en passant à travers le châssis.

**Attention** ⚠ Ne mettre de la colle que sur le bout de l'essieu.

**Astuce** : tourner les roues pendant le séchage pour éviter qu'elles ne se collent au châssis.

Glue the remaining wheels. Remember to place the axle through the car body.

**Be careful** ⚠ Place glue only on the axle tips.

**TIP** : Turn the wheels regularly while it's drying. That way, they won't be glued to the body.

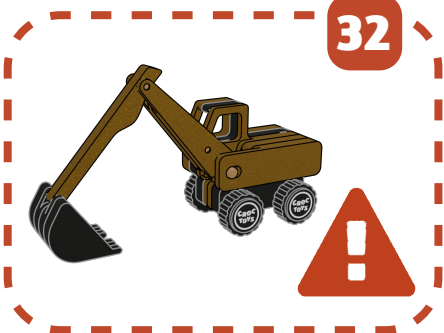

32

Inspection visuelle et vérification que tout tient bien par un **adulte** !

Finally, ask a friendly **adult** to check your creation.



33

**Jouer !**  
**Have fun playing !**

[www.croctoys.com](http://www.croctoys.com)



Attention ne convient pas aux enfants de moins de 36 mois  
Petits éléments.

Danger d'étouffement.  
numéro de production : 0003  
Informations à conserver



Fabriqué par :  
SARL MaxProd  
110 rue de la Viale  
26750 Geyssans

Croc Toys est une marque déposée