

CROC  
toys

# NOTICE DE MONTAGE BUILDING INSTRUCTION

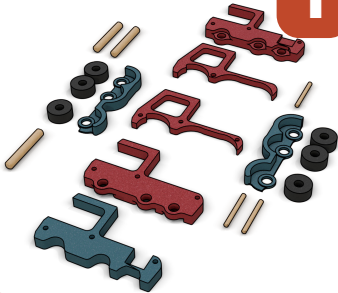

1



Séparer délicatement les pièces des  
planches.

Gently detach all the pieces from the  
boards.



2

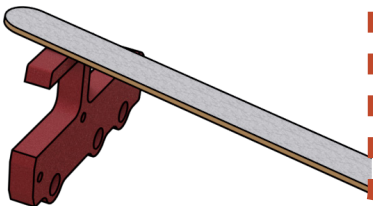

Poncer les attaches restantes à l'aide  
de la lime.

Sand the leftover attachment tabs with  
the included file.

3

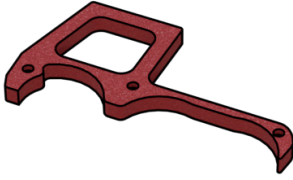

Trouver la première pièce.

Find this first piece.

4

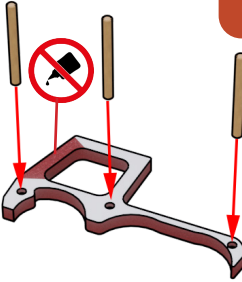

Encoller la face de la pièce et insérer les chevilles.

Place glue on the face of the piece and then insert the dowels.

5

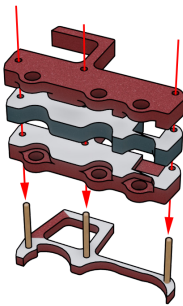

Encoller et insérer les 3 pièces centrales

**Attention** ⚠️

bien positionner les attaches de roues sur l'extérieur

Glue and insert in place the 3 center pieces.

**⚠️ Be careful**

The wheel attachment needs to be on the outer side

6

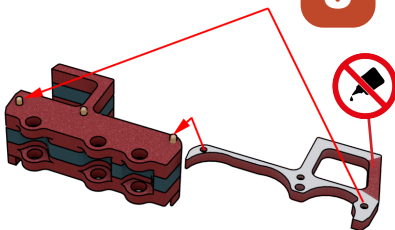

Encoller et placer la seconde pièce latérale.

Glue and place the second side piece.

7

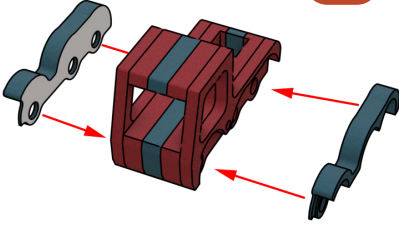

Coller les garde-boue.

Glue on wheel arches.

8

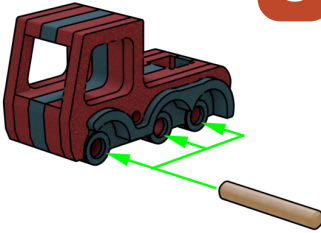

Bien nettoyer l'excédent de colle.  
Utiliser un essieu pour nettoyer les axes  
des roues.

Carefully remove the excess glue. Use  
a wheel axle to clean the wheel axle  
holes.

9

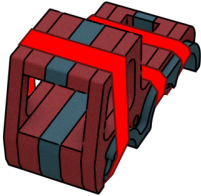

Utiliser les élastiques pour maintenir la  
pression pendant que la colle sèche.

Retirer de nouveau l'excédent de colle si  
nécessaire

Use the elastic bands to clamp the car  
body while the glue dry.

If necessary, remove any excess glue  
again.

10

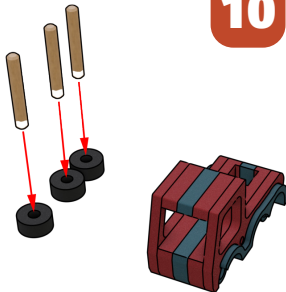

Coller une roue sur chaque essieu.

**Attention** ⚠️

Ne mettre de la colle que sur le bout de  
l'essieu.

Glue one wheel on each wheel axle.

**⚠️ Be careful**

Place glue only on the tip of the axle.

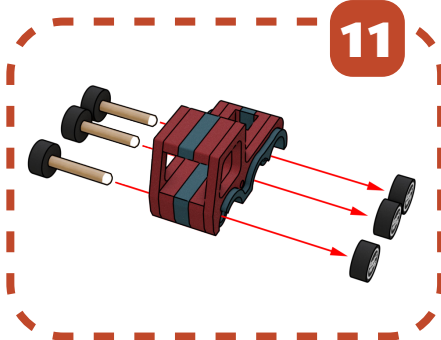

Coller les roues restantes en passant à travers le châssis.  
**Attention** ⚠ Ne mettre de la colle que sur le bout de l'essieu.  
**Astuce** : tourner les roues pendant le séchage pour éviter qu'elles ne se collent au châssis.

Glue the remaining wheels. Remember to place the axle through the car body.  
**Be careful** ⚠ Place glue only on the tip of the axle.

**TIP** : Turn the wheels regularly while it's drying. That way, they won't be glued to the car body.

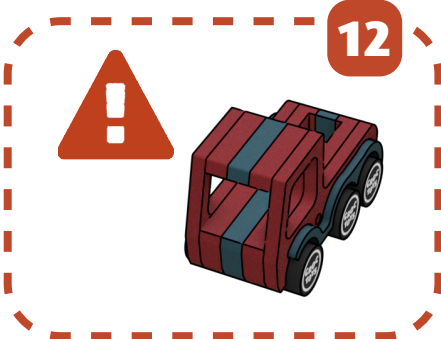

Inspection visuelle et vérification que tout tient bien par un **adulte** !

Finally, ask a friendly **adult** to check your creation.



**Jouer !**  
**Have fun playing !**

[www.croctoys.com](http://www.croctoys.com)



Attention ne convient pas aux enfants de moins de 36 mois  
Petits éléments.  
Danger d'étouffement.  
numéro de production : 0003  
Informations à conserver



Fabriqué par :  
SARL MaxProd  
110 rue de la Viale  
26750 Geyssans

Croc Toys est une marque déposée